

the Barista Touch™ Impress

BES881/SES881



EN USER GUIDE

Sage®



Contents

- 2 Sage® Recommends Safety First
- 6 Features
- 7 Components
- 9 Assembly
- 10 Functions
- 20 Care & Cleaning
- 24 Troubleshooting
- 25 Guarantee

SAGE® RECOMMENDS SAFETY FIRST

At Sage® we are very safety conscious. We design and manufacture consumer products with the safety of you, our valued customer, foremost in mind. In addition, we ask that you exercise a degree of care when using any electrical appliance and adhere to the following precautions.

IMPORTANT SAFEGUARDS

READ ALL INSTRUCTIONS BEFORE USE AND SAVE FOR FUTURE REFERENCE

- A downloadable version of this document is also available at sageappliances.com.
- Remove and discard any packaging materials safely before use.
- Ensure the product is properly assembled before first use and fully unwind the power cord before operating.
- Before using for the first time, please ensure that your electricity supply is the same as shown on the rating label on the underside of the appliance (220-240 V ~ 50-60 Hz 1430-1700 W). If you have any concerns, please contact your local electricity company.
- The installation of a residual current safety switch is recommended to provide additional safety when using all electrical appliances. Safety switches with a rated operating current not more than 30mA are recommended. Consult an electrician for professional advice.

- Regularly inspect the power cord, plug and actual appliance for any damage. If found to be damaged in any way, immediately cease use of the appliance, and return the entire appliance to the nearest authorised Sage Service Centre for examination, replacement, or repair.
- Do not let the power cord hang over the edge of a counter or table. Do not let the power cord touch hot surfaces or become knotted.
- Do not touch hot surfaces. Always ensure the appliance has been allowed to cool; if the appliance is to be: left unattended, cleaned, moved, assembled or stored, or when changing accessories; always switch off the espresso machine by pressing the POWER button to OFF. Switch off and unplug from the power outlet.
- Children must not play with the appliance. Do not leave the appliance unattended when in use. Do not move the appliance whilst in operation.
- This appliance can be used by children aged from 8 years and above, and by persons with reduced physical, sensory, or mental capabilities or lack of experience and knowledge if they have been given supervision or instruction concerning use of the appliance in a safe way and understands the hazards involved. Cleaning and user maintenance shall not be made by children unless they are older than 8 and supervised. Keep the appliance and its cord out of reach of children aged less than 8 years.
- To eliminate a choking hazard for young children, discard the protective cover fitted to the power plug safely.
- Position the appliance on a stable, heat resistant, level, dry surface away from the counter edge, and do not operate on or near a heat source such as a hot plate, oven, or gas hob.
- Do not operate the appliance in an enclosed space, or inside a cupboard.
- Do not use attachments other than those provided with the appliances. The use of attachments not sold or recommended by Sage® may cause fire, electric shock, or injury.
- This appliance is for household use only. Do not use the appliance for anything other than its intended purpose. Do not use in moving vehicles or boats. Do not use outdoors. Misuse may cause injury.

- Servicing should only be performed by an authorised service representative.
- Improper use of the appliance incorrectly operated or unprofessionally repaired. In such a case, any warranty claim is void. No warranty claim for any damages can be accepted.
- The appliance is not intended to be operated by means of an external timer or separate remote-control system.
- Use caution when operating machine as metal surfaces are liable to get hot during use. Heating element is subject to residual heat after use.
- Do not put fingers into the tamping chute when pushing down the tamping lever.
- Do not open the programming port, this is exclusively for authorised service personnel only.
- Do not operate the grinder without the hopper lid in position. Keep fingers, hands, hair, clothing, and utensils away from the hopper during operation.
- Do not fill water tank with hot water.
- Never use the appliance without water in the water tank.

- Wipe the outer surface with a soft, damp cloth and then polish with a soft, dry cloth. Keep the appliance and accessories clean. Follow the cleaning instructions provided.

 **CAUTION**

To prevent damage to the appliance, do not use alkaline cleaning agents when cleaning, use a soft cloth and a mild detergent.



The symbol shown indicates that this appliance  should not be disposed of in normal household waste. It should be taken to a local authority waste collection centre designated for this purpose or to a dealer providing this service. For more information, please contact your local council office.



To protect against electric shock, do not immerse the power cord, power plug or appliance in water or any other liquid.

NOTICE TO CUSTOMERS REGARDING MEMORY STORAGE SAVE THESE INSTRUCTIONS

Please note that in order to better serve our customers, internal memory storage has been imbedded into your appliance. This memory storage consists of a small chip to collect certain information about your appliance including the frequency of use of the appliance and the manner in which your appliance is being used. In the event your appliance is returned for service, the information collected from the chip enables us to quickly and efficiently service your appliance.

The information collected also serves as a valuable resource in developing future appliances to better serve the needs of our consumers. The chip does not collect any information regarding the individuals who use the product or the household where the product is used. If you have any questions regarding the memory storage chip please contact us at privacy@sageappliances.com

SPECIFIC INSTRUCTIONS FOR WATER FILTER

- Filter cartridge should be kept out of reach of children.
- Store filter cartridges in a dry place in the original packaging.
- Protect cartridges from heat and direct sunlight.
- Do not use damaged filter cartridges.
- Do not open filter cartridges.
- If you are absent for a prolonged period of time, empty the water tank and replace the cartridge.

FOR HOUSEHOLD USE ONLY SAVE THESE INSTRUCTIONS



Features

RAPID HEAT UP

Innovative heating system achieves ideal extraction temperature in 3 seconds.

PRECISION CONICAL BURR GRINDER

Precision conical burrs maximise ground coffee surface area for a full espresso flavour.

STEP-BY-STEP BARISTA GUIDANCE

Swipe & select from the drink's menu. Receive guidance throughout the whole coffee making process so you can enjoy a perfect cup of coffee. Adjust your shot volume, milk texture or milk temperature, then save it as your personal favourite.

ADJUSTABLE GRIND SIZE

Espresso grind settings from fine to coarse for optimal extraction.

ADJUSTABLE GRIND AMOUNT

Adjust the amount of fresh ground coffee dosed into the filter basket to suit the fineness or coarseness of the grind.

PID TEMPERATURE CONTROL

Electronic PID temperature control for increased temperature stability.

DEDICATED HOT WATER SPOUT

Dedicated hot water outlet for making long blacks, teas, and pre-heating cups.

LESS MESS

The portafilter remains secure in the same position as you grind, dose and tamp, reducing any potential grinds mess on your drip tray and bench top.

THE BARISTA TOUCH™ IMPRESS PUCK SYSTEM

Simplifies the steps needed to grind, dose, and tamp to create an impressive puck. Less mess. Less fuss.

- **Precision Measurement Auto Corrects the Next Dose**

Grind measurement displayed on screen indicates when correct level is achieved, and the system automatically remembers the adjustment for the next dose.

Correct dose level is calculated based on measured grind amount.

- **Assisted Tamping with a 7° Barista Twist Finish**

Precise 10kg impression with a professional 7 degree barista twist for a polished puck.

AUTOMATIC HANDS-FREE MILK TEXTURING

Automatically textures milk to the selected temperature and style from silky smooth latté to creamy cappuccino. Choose your preferred milk type to optimize your milk results for dairy, almond, soy and oat milk. Automatic purge removes residual milk from the steam wand once texturing is complete.



Components



- A. 340g Bean Hopper
- B. Touch Screen
- C. Power Button
- D. Tamp Lever
- E. Grind Size Adjustment Dial
- F. Removable Tamp Cover
- G. Grinding Cradle
- H. Group Head

- I. Hot Water Spout
- J. 54mm Stainless Steel Portafilter
- K. Steam Wand
- L. Drip Tray Grill
- M. Milk Temperature Sensor
- N. Drip Tray

NOT SHOWN

- 2 L Removable Water Tank
- Tool Storage Tray
- Power Cord Storage



Rating Information

220-240V ~ 50-60Hz 1430-1700 W

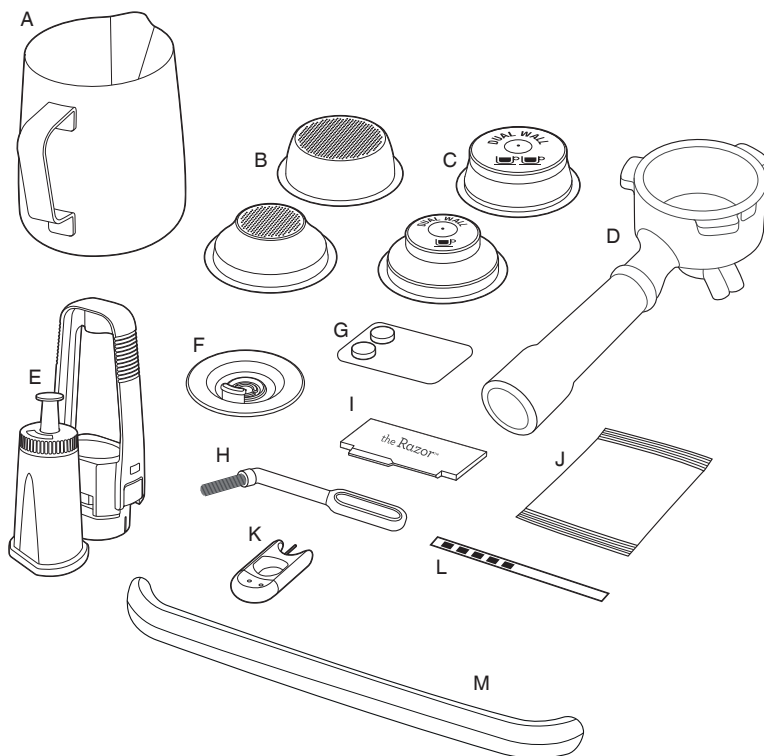

ACCESSORIES

- A. Stainless Steel Milk Jug
- B. 1 cup & 2 cup Single Wall Filter Baskets
- C. 1 cup & 2 cup Dual Wall* Filter Baskets
- D. 54mm Stainless Steel Portafilter
- E. Water Filter Holder With Filter
- F. Cleaning Disc
- G. Cleaning Tablets
- H. Cleaning Brush
- I. The Razor™ precision dose trimming tool
- J. Descale Powder
- K. Cleaning Tool For Steam Wand Tip
- L. Water Hardness Strip
- M. Drip Tray Guard
(included with machines in colour only)

* 2 cup dual wall filter basket comes installed in the portafilter



Assembly

BEFORE FIRST USE

Machine Preparation

Remove and discard all labels and packaging materials attached to your espresso machine.

Ensure you have removed all parts and accessories from the box before discarding the packaging.

Remove the water tank located at the back of the machine by pulling the water tank handle.

Clean parts and accessories (water tank, portafilter, filter baskets, jug) using warm water and a gentle dish washing liquid. Rinse well then dry thoroughly.



NOTE

Machines with colour, drip tray protection guard is included. **DO NOT DISCARD.**

INSTALLING THE WATER FILTER

- Remove the water filter and water filter holder from the plastic bag.
- Soak the filter in cold water for 5 minutes.
- Rinse the filter holder with cold water.

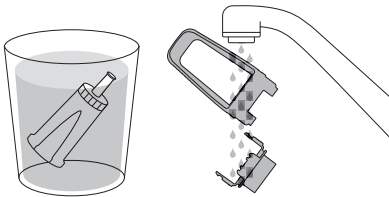

- Set the reminder for next month of replacement. We recommend to replace the filter after 3 months.

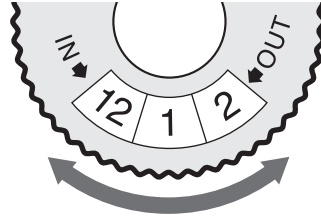

- Insert the filter into the two parts of the filter holder.
- To install the assembled filter holder into the water tank, align the base of the filter holder with the adapter inside the water tank. Push down to lock into place.

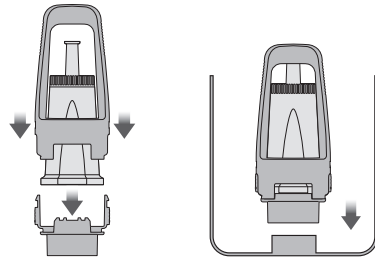

NOTE

Replacing the water filter every three months will reduce the need to descale the machine. Filters can be purchased at www.sageappliances.com



NOTE

If your water hardness is either 4 or 5 when tested, we strongly recommend you to change to an alternate water source. Filtered water will extend both the life of your built-in filter and descale intervals as well as superior taste. Please ensure to test the water hardness of the alternative water source you've chosen and input into the machine accordingly. Avoid using overly filtered water, like RO water unless some mineral content is being added back to the final water. Never use distilled water, or water with no or low mineral content as this will affect the taste of coffee.



Functions

Filling the Water Tank

- Ensure the water filter is securely fitted inside the water tank.
- Use the handle at the top of the water tank to assist in lifting the water tank and away from the machine.

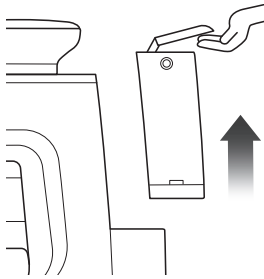

- Fill the water tank with cold potable tap water up to the MAX marking indicated on the side of the water tank.
- Replace the water tank back on the machine, pressing down to ensure that it is properly positioned and attached to the machine.

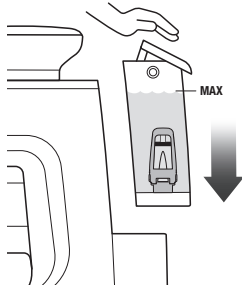

NOTE

If the water level in the water tank is below the minimum (MIN) marking, the espresso machine will not operate.

Attaching the Hopper

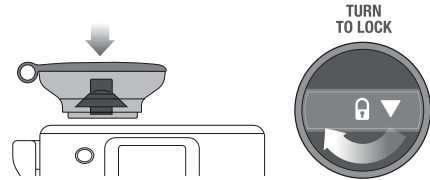

- Insert the bean hopper into position on top of the machine.
- Turn the dial to lock the hopper into place.
- Fill the hopper with fresh beans.



TIP

We recommend quality 100% Arabica beans with a 'Roasted On' date stamped on the bag, not a 'Best Before' or 'Use By' date. Coffee beans are best consumed between 5–20 days after the 'Roasted On' date. Stale coffee may pour too quickly from the portafilter spouts and taste bitter and watery.

Attaching the Drip Tray

- Place the drip tray grill on top of the drip tray.
- Machines with colour, attach the drip tray protection guard cover on the drip tray.
- Slide the drip tray into the machine.



NOTE

Using the drip tray protection guard cover is optional. But note that using the drip tray protection guard can protect your drip tray from dents and scratches.

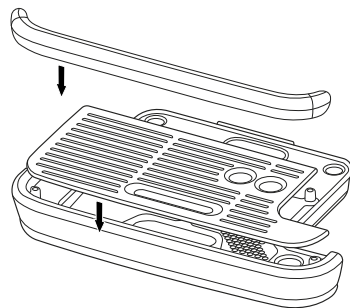

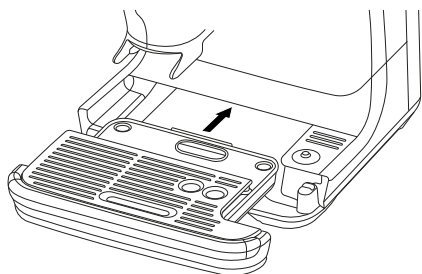

GENERAL OPERATION

- Check the water tank is filled with cold tap water up to the maximum mark.
- Plug the power cord into the power outlet.
- Press the 'Power' button.
- Follow the instructions on screen to guide you through first use setup.

DRINK SELECTION

Swipe and select your choice of drink.



NOTE

Please keep the touch screen dry and clean to ensure that the machine functions properly.

DRINK SCREEN

In this screen, you can customise your drink by touching the choice of drink on screen.



- Home icon
- Chosen drink
- Hot water
- Grind / Dose = tap the icon below the portafilter to adjust grinder settings.
- Brew = tap the icon below the coffee glass to adjust brewing settings.
- Milk texture = tap the icon below the milk jug to adjust milk settings.

SETTING THE GRIND SIZE AND DOSING

- Adjust the grind size by using the dial on the side of the machine.



- Follow the screen prompts to select the preferred 'Basket Size'.
- Tap on the portafilter image to start the grinding and allow fresh ground coffee to fill the portafilter.



- Grinding will automatically stop.

ASSISTED TAMPING

- When grind cycle is completed, the machine is ready to tamp.



- Push the lever downwards to the end position. This will tamp the coffee grinds in the portafilter using a consistent amount of tamp force. Pushing the lever slowly and consistently will help to improve the puck appearance.
- Release the lever slowly upwards to the home position after tamping.
- Repeat the tamping action as above twice.



NOTE

Screen will indicate if tamp or dose is low, ideal or high.

HOW TO CORRECT AN UNDER OR OVER DOSE?

An under or over dose can occur when fresh beans are added to the hopper; when coffee beans age; a different type of coffee bean is used or if a change is made to the grind size.

What to do when dose level is below the ideal middle bar?

- When dose is below the ideal middle bar, the machine will indicate and calculate 'A Bit More'. Tap the portafilter image on screen to add a bit more and follow screen prompts and complete a tamp for an updated dose level reading.
- When ideal dose level is reached, the machine will automatically update the auto dose time for the next cycle.

What to do when dose level is above the ideal middle bar?

- When dose is above the ideal middle bar, remove the portafilter from the cradle.
- Use the Razor Trimming Tool. (refer to Trimming the Dose section).
- The machine will calculate how much to reduce the auto grind time and apply this for the next cycle.

OVER DOSE (TRIMMING THE DOSE)

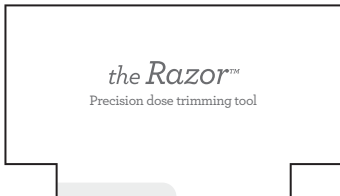

The Razor™ precision dose trimming tool allows you to trim the puck to the right level for a consistent extraction.

Insert the Razor™ into the coffee basket until the shoulders of the tool rest on the rim of the filter basket. The blade of the dosing tool should penetrate the surface of the tamped coffee.

Rotate the Razor™ dosing tool back and forth while holding the portafilter on an angle over the knock box to trim off excess coffee.



Inserting the Portafilter

Place the portafilter underneath the group head so that the handle is aligned with the INSERT position. Insert the portafilter into the group head and rotate the handle towards the centre until resistance is felt.

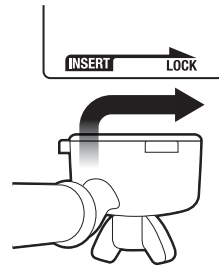

ESPRESSO EXTRACTION

- Select a display of brew options on the screen.
- Select the café size options from: Single (approx.30ml), Double (approx.60ml) or Double+ (approx.90ml).
- Select Custom and slide and drag the dot to increase or decrease the coffee volume.
- Tap the coffee cup image on the screen to start extraction.
- The duration times are preset but can be customised.



MANUAL OVERRIDE

Press and hold the coffee image (approx 2 seconds) to enter manual extraction mode. Touch the coffee image to start the extraction, touch the coffee image again to stop the extraction.



NOTE

- The amount of espresso extracted in the cup will vary depending on your grind size and grind amount settings.
- Touching the coffee image during a preset shot volume will immediately stop the extraction.
- For optimal flavour when using a 1 CUP filter basket, you should extract approx. 30ml. When using a 2 CUP filter basket, you should extract approx. 60ml.

TEXTURING MILK

Different brands and milk alternatives will texture differently. For best texturing results it is recommended to use full cream milk when using dairy milk and use barista type milks when using plant-based milks. You may need to adjust the froth level accordingly. Start with cold milk. Fill milk jug to below the spout position. Lift the steam wand and insert into milk jug. Lower steam wand, ensuring it is fully down. The milk jug should rest on the milk temperature sensor located on the drip tray and tip of the steam wand should be submerged and ensure that milk covers the ring around the steam wand tip.

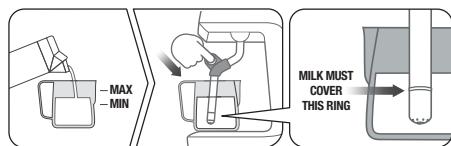

NOTE

Check the image on the screen for the correct milk jug position.

Under the milk jug image, tap the icon to adjust the milk temperature, the level of milk froth or change your milk option: Dairy, Almond, Oat or Soy.

To start, touch the 'Milk jug' image. The screen will display the temperature of the milk as it heats.



Milk texturing will stop automatically when the selected milk temperature is reached.

Lift steam wand to remove milk jug. Wipe the wand and tip with a clean damp cloth. Lower steam wand to the down position and the wand will automatically purge.

MANUAL MILK TEXTURING

Auto milk texturing and auto shut-off are disabled during manual milk texturing mode. Start with a cold milk. Fill milk jug to below the spout position. Lift the steam wand and slide the milk jug under the steam wand. Hold the milk jug at an angle.

Start frothing by tapping the milk jug icon on screen. When frothing is done and the jug is hot to comfortably touch; tap the milk jug icon on screen to stop.

Wipe the wand & tip with a clean damp cloth. Lower steam wand to the down position and the wand will automatically purge.



CAUTION: BURN HAZARD

Pressurised steam can still be released, even after machine has been switched off. Children must always be supervised.

NOTE

- When the machine creates steam, a pumping noise can be heard. This is the normal operation of the pump.
- Use exclusively the stainless steel milk jug included in the pack to froth milk. The use of container made of glass or plastic material to froth milk may lead to overheating milk or dangerous conditions.

USING HOT WATER

The machine has a dedicated hot water spout. The HOT WATER function can be used to pre-heat cups or add hot water manually. To start and stop hot water, touch 'Hot Water' icon on the screen.

Hot water limit is approximately 90 seconds. Depending on the size of your cup, you may need to touch the 'Hot Water' button to stop pouring.

NOTE

Using the hot water spout and the steam wand is not possible when extracting espresso.

Run hot water before or after extracting espresso.



WARNING

Filled cup temperature is approximately 75°C - 90°C (167°F - 194°F). Be careful in handling hot beverages.

TIP

Heating your cup or glass

A warm cup will help maintain the coffee's optimal temperature. Pre-heat your cup by rinsing with hot water from the hot water outlet and place on the cup warming tray.

Heating the portafilter and filter basket

A cold portafilter and filter basket can reduce the extraction temperature enough to significantly affect the quality of your espresso. Always ensure the portafilter and filter basket are pre-heated with hot water from the hot water spout before initial use.

NOTE

Always wipe the portafilter and filter basket dry before dosing with ground coffee as moisture can encourage 'channeling' where water bypasses the ground coffee during extraction.

FILTER BASKETS

This machine includes both single and dual wall, 1 cup and 2 cup filter baskets.

Use the 1 cup filter basket when brewing a single cup and the 2 cup filter baskets when brewing 2 cups or a stronger single cup or mug.

The provided filter baskets are designed for ground coffee:

1 cup filter basket = 8-11g

2 cup filter basket = 16-19g

Single Wall Filter Baskets

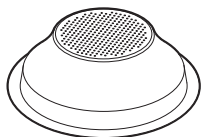

1 CUP

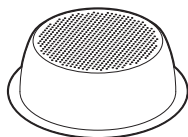

2 CUP

Single Wall filter baskets should be used when grinding fresh whole coffee beans.

These allows you to experiment with grind and dose to create a more balanced espresso.

Dual Wall Filter Baskets



1 CUP



2 CUP

Dual Wall filter baskets should be used when using pre-ground coffee and older beans that are past the 30-day roast date.

These regulate the pressure and help to optimize the extraction regardless of the grind, dose, or freshness.

THE GRIND

Adjusting the Grind Size

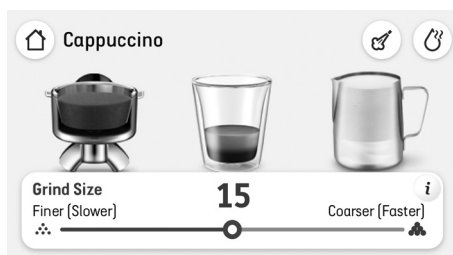

The grind size will affect the rate of water flow through the coffee in the filter basket and the flavour of the espresso. When setting the grind size, it should be fine but not too fine and powdery.

To adjust the grind, rotate the grind dial to the back of the machine to go coarser, or rotate the dial towards the front of the machine to go finer or slide the dot on the screen to the left for a finer grind or to the right for a coarser grind. The smaller the value shown on screen, the finer the grind size. The larger the value shown on screen, the coarser the grind size.



NOTE

- When making changes to the grind size, the new auto dosing time will be calculated after your next tamp and updated for the dose cycle following that. The dose amount is calculated and stored automatically. Two to three extractions may be required to calibrate the extraction.
- For most bean varieties, the grinder will pause the grind operation when coffee beans ran out.

Extracting Espresso

- As a guide, the espresso will start to flow after 8-12 seconds (infusion time) and should be the consistency of dripping honey.
- If the espresso starts to flow before 7 seconds you have either under dosed the filter basket and/or the grind is too coarse. This is an UNDER-EXTRACTED shot.
- If the espresso starts to drip but doesn't flow after 12 seconds, then you have either over dose the filter basket and/or the grind is too fine. This is an OVER-EXTRACTED shot.

A great espresso is about achieving the perfect balance between sweetness, acidity, and bitterness.

The flavour of your coffee will depend on many factors, such as the type of coffee beans, degree of roast, freshness, coarseness or fineness of the grind, and the dose of ground coffee.

Experiment by adjusting these factors just one at a time to achieve the taste of your preference.

HOW TO ADD & DELETE CUSTOMISED DRINKS

Adding A New Drink

When customising a default drink, tap the disc icon on the upper right of the screen to rename and save newly created coffee settings. Name the new drink with a maximum of 15 characters. Every created drink is saved to the start of the drink carousel.

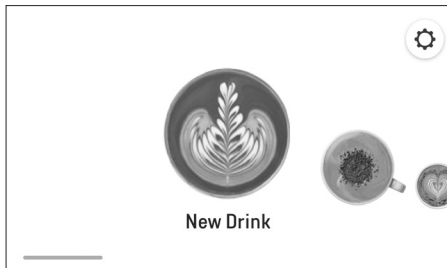

Editing Or Deleting A Saved Drink

Select the name of the saved drink and tap and hold the coffee image for three seconds and select either 'Edit' or 'Delete' from the screen. Press 'Yes' to confirm or 'No, cancel' to return to the drink carousel screen.

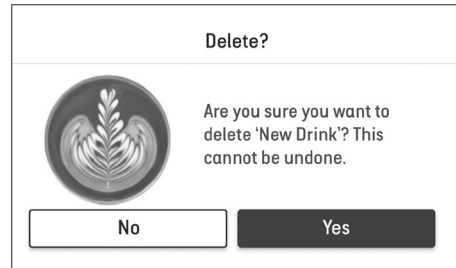
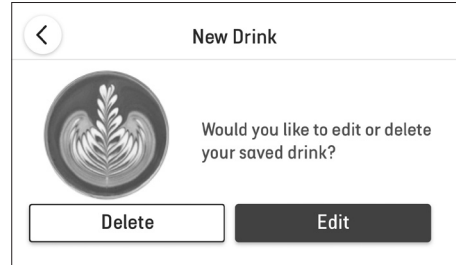

SETTINGS

To enter settings menu, touch the icon on the upper right of the screen.

MAINTENANCE

Clean Steam Wand – This will show how to clean the steam wand to remove any blockage for better steaming performance.

Group Head Cleaning – This will need Espresso cleaning tablet or powder and will take 10 minutes to complete.

Grinder Cleaning – Follow step-by-step process to clean the grinder to help the grinder running in its optimal capacity and avoid possible blockages.

Descale – Descaling prevents excess mineral and scale build-up. A pop-up message will let you know when it is time for descaling.

Water Filter Change – To ensure machine has clean water to use.

DRINK SETTINGS

Intelligent Dose – To turn on or off 'Intelligent Dosing' that measures the dose and enables the intelligent brewing calibration feature.

Default Milk – List of different kinds of milk and select the desired milk default.

Coffee Tutorial – Machine will guide you on screen, step by step to make an actual coffee.

OTHER

Notifications – List of the machine notification alerts.

Guidance Tips – To turn on and off the guidance tip animations on the drink screen.

Date & Time – To help set the date and time on the machine.

Units – To switch between imperial and metric units.

Help – Online help information screen with QR Code.

Language – To set the machine's language.

Demo mode – For on-screen Barista Touch™ Impress demonstration sequence.

About Appliance – To show model number and firmware version of the machine.

Factory Reset – Use this function to reset all programmable values back to the factory settings and delete all custom drinks.

ADJUSTING CONICAL BURRS

Some types of coffee may require a wider grind range to achieve an ideal extraction or brew. A feature of your Barista Touch™ Impress is the ability to extend this range with an adjustable upper burr. We recommend making only one adjustment at a time.

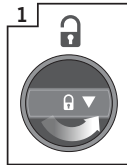
- 

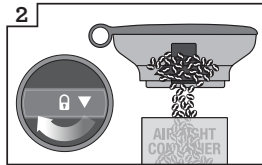
1
Unlock hopper
- 

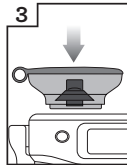
2
Hold hopper over container & turn dial to release beans into container
- 

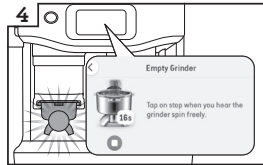
3
Align hopper into position
- 

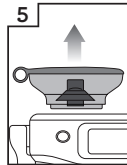
4
Run grinder until empty
- 

5
Remove hopper
- 

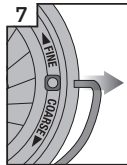
6
Remove upper burr
- 

7
Remove wire handle from both sides of the burr
- 

8
Move adjustable top burr, 1 number, coarser or finer
- 

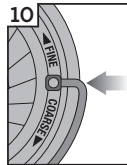
9
Align the number with the handle opening
- 

10
Insert wire handle from both sides of the burr
- 

11
Push upper burr firmly into position
- 

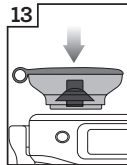
12
Lock upper burr
- 

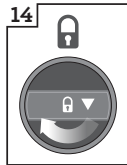
13
Align hopper into position
- 

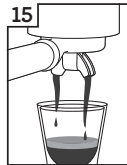
14
Lock the hopper and fill the hopper with beans.
- 

15
Check your extraction



Care & Cleaning

COLOUR TOUCH SCREEN DISPLAY

Please keep the touch screen dry and clean to ensure that the machine functions properly.

REPLACING THE WATER FILTER IN THE WATER TANK

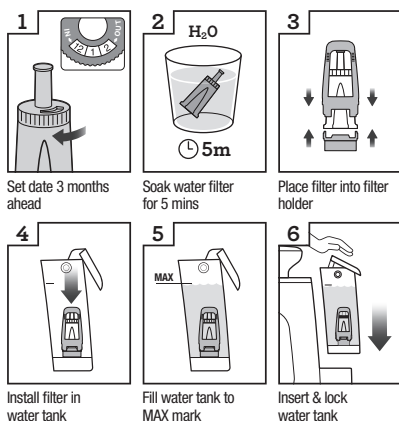

The provided water filter helps reduce the risk of scale build-up in and on many of the inner functioning components. Replacing the water filter every three months will reduce the need to descale the machine. If you live in a hard water area, it is recommended to change the water filter more frequently.

- Remove the filter from the plastic bag, and soak in a cup of water for 5 minutes.
- Rinse the filter under cold running water for 5 seconds.
- Insert the filter into the filter holder.
- Set the date dial 3 months ahead.
- To install, push down the filter to lock into place.



NOTE

For replacement of water filters contact Sage Customer Service Centre or visit our website at www.sageappliances.com.

CLEANING CYCLE

There will be a message prompt when a cleaning cycle is required. This is a back-flushing cycle and is separate from descaling. Follow the instruction on the screen.



WARNING

After regular use, hard water can cause mineral build up in and on many of the inner functioning components, reducing the brewing flow, brewing temperature, power of the machine, and taste of the espresso.

DESCALING

Even with the provided water filter, it is recommended to descale if there is scale build-up in the water tank.

Go to 'Settings' and select 'Descal cycle'. Follow the instructions on the screen.

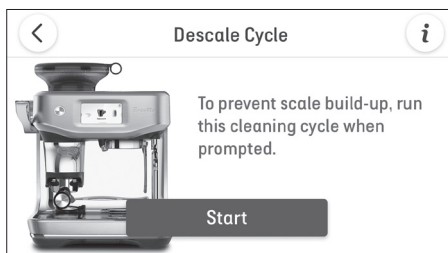

NOTE

Ensure that the water filter is removed from the water tank before adding the descaling powder when descaling the machine.

- While the cleaning cycle is important for keeping the brew head clean from coffee oils; the descaling cycle is essential to ensure that the machine is kept clean on the inside and free from mineral build-up.
- Do not use bottled water when descaling. Most bottled water may contain dissolved solids that can leave deposits inside the machine.

CLEANING CONICAL BURRS

Regular cleaning helps the burrs achieve consistent grinding results.

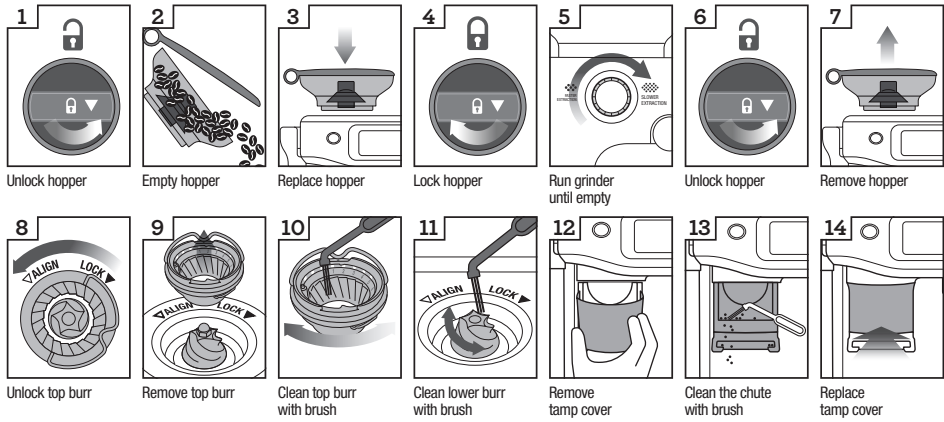

ADVANCED CLEANING FOR THE CONICAL BURR GRINDER

This step is only required if there is a blockage between the grinding burrs and the grinder outlet.

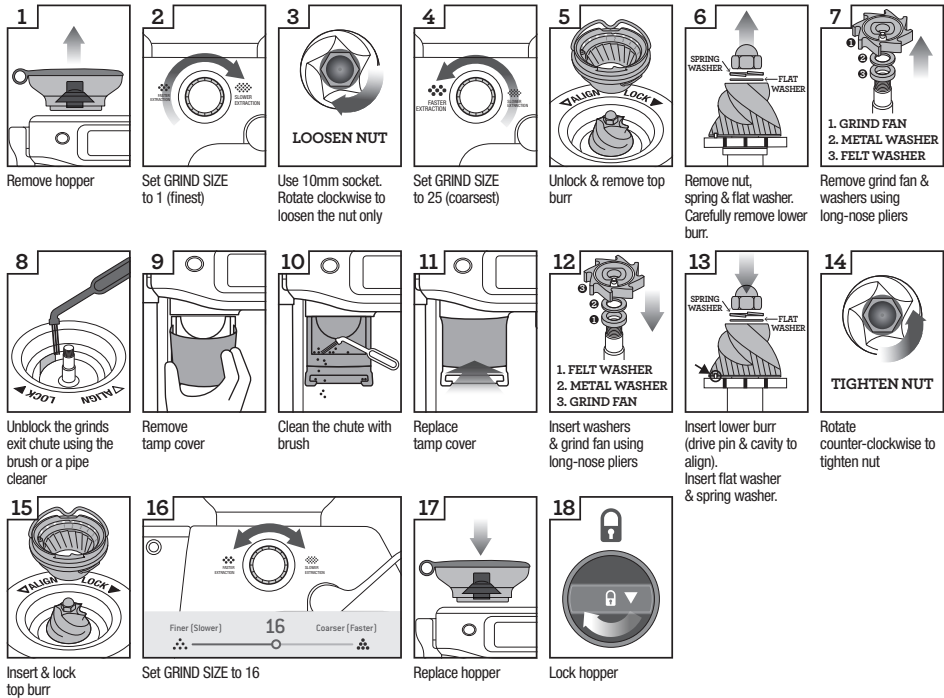

Care should be taken as the grinder burrs are extremely sharp.

CLEANING THE TAMP SYSTEM

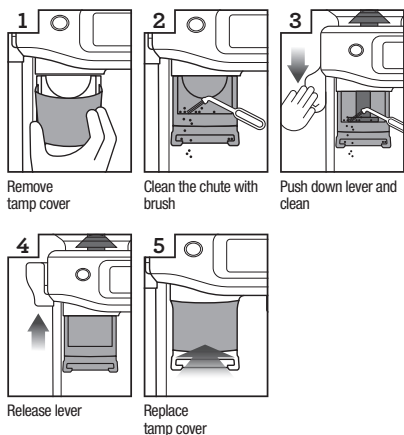

- Remove the tamp cover.
- Brush clean the tamp face and cradle from any dust or grinds.
- Push down and hold the lever down, using the tamp cleaning brush, dust off grind residues in and around the tamp.
- Slowly release the lever back up making sure the cleaning brush is clear and out of the tamp system area.

CLEANING THE STEAM WAND

- The steam wand should always be cleaned after texturing milk. Wipe the steam wand with a damp cloth.
- If any of the holes in the tip of the steam wand become blocked, it may reduce frothing performance.
- Go to 'Settings' > 'Steam wand cleaning' and follow the guide on the screen.



CLEANING THE FILTER BASKETS AND PORTAFILTER

- The filter baskets and portafilter should be rinsed under hot water immediately after use to remove all residual coffee oils.
- If any of the holes in the filter basket become blocked, use the pin on the end of the provided cleaning tool to unblock the hole(s).
- If the hole(s) remain blocked, dissolve a cleaning tablet in hot water and soak filter basket and portafilter in solution for approx. 20 minutes.
- Rinse thoroughly.

CLEANING THE SHOWER SCREEN

- The group head interior and shower screen should be wiped with a damp cloth to remove any ground coffee particles.
- Periodically purge the machine. Place an empty filter basket and portafilter into the group head. Tap the brewing icon on the screen and run a short flow of water to rinse out any residual coffee.

CLEANING THE DRIP TRAY AND STORAGE TRAY

- The drip tray should be removed, emptied and cleaned at regular intervals, particularly when the drip tray is full.
- Remove the grill from the drip tray. Lift the coffee grind separator and dispose of any coffee grounds. The float indicator can also be removed from the drip tray by pulling upwards to release the side latches. Wash all parts in warm soapy water with a soft cloth. Rinse and dry thoroughly.
- The storage tray (located behind the drip tray) can be removed and cleaned with a soft, damp cloth. Do not use abrasive cleansers, pads or cloths which can scratch the surface.

NOTE

All parts should be cleaned by hand using warm water and a gentle dish washing liquid. Do not use abrasive cleansers, pads or cloths which can scratch the surface. Do not clean any of the parts or accessories in the dishwasher.

CLEANING THE OUTER HOUSING AND CUP WARMING TRAY

- The outer housing and cup warming tray can be cleaned with a soft, damp cloth. Polish with a soft, dry cloth. Do not use abrasive cleansers, pads or cloths which can scratch the surface.

STORING YOUR MACHINE

- Before storing, press the POWER button to OFF, switch off at the power outlet and unplug. Remove unused beans from the hopper, clean the grinder, empty the water tank and the drip tray.
- Ensure the machine is cool, clean and dry. Insert all accessories into position or into the storage tray. Store upright. Do not place anything on top.



WARNING

To prevent damage, do not use alkaline cleaning agents when cleaning. Use a soft cloth and a mild detergent.



WARNING

Do not immerse power cord, power plug or appliance in water or any other liquid. The water tank should never be removed or completely emptied during decalcifying.

CLEANING THE SHOWER SCREEN

Over time, the silicone seal surrounding the shower screen will need to be replaced to ensure optimum brewing performance.

1. Press the POWER button to switch the machine off and unplug the cord from the power outlet.
2. Carefully remove the water tank and drip tray, taking particular care if they are full.
3. Using a skewer or similar, clean the centre of the screw of any residual coffee.
4. Use a flat screw driver (not provided) to unscrew. Turn counterclockwise to loosen the screw.

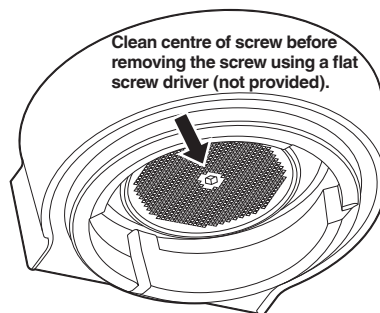

5. Once loosened, carefully remove and retain the screw and stainless-steel shower screen. Make note of the side of the shower screen that is facing downwards. This will make re-assembly easier. Wash the shower screen in warm soapy water, then dry thoroughly.
6. Remove the silicone seal with your fingers or a pair of long-nose pliers. Insert the new seal, flat side first, so the ribbed side is facing you.

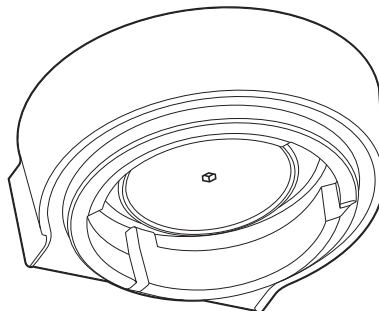

7. Re-insert the dispersion plate, then the shower screen, then the screw. With your fingers, turn the screw clockwise for 2-3 revolutions and use a flat screw driver to tighten until the screw is flush with the shower screen.
8. Re-insert the drip tray and water tank.



NOTE

Contact Sage Customer Service or visit www.sageappliances.com for replacement silicone seals or for advice.



Troubleshooting

PROBLEM	POSSIBLE CAUSES	WHAT TO DO
Water does not flow from the group head	<ul style="list-style-type: none">• Water tank is empty.• Water tank is not fully inserted and locked into position.	<p>Fill tank.</p> <p>Push water tank in fully and lock latch closed.</p>
No hot water	<ul style="list-style-type: none">• Water tank is empty.	<p>Fill water tank.</p>
No steam	<ul style="list-style-type: none">• Steam wand is blocked.	<p>Use the pin on the end of the provided cleaning tool. If steam wand remains blocked, remove the tip using the integrated spanner in the cleaning tool and soak in hot water. Screw tip back onto the steam wand using the integrated spanner in the cleaning tool.</p>
The machine is ON but ceases to operate		<p>Turn machine off. Wait for 60 minutes and turn machine back on. If problem persists, call Sage Consumer Support.</p>
Coffee runs out too quickly	<ul style="list-style-type: none">• The coffee grind is set too coarse.• Not enough ground coffee in the filter.	<p>Adjust the grind size to a lower setting.</p> <p>Refer to 'Setting The Grind Size And Dosing' under  Functions.</p>
Coffee is too cold	<ul style="list-style-type: none">• Cups not preheated.• Milk not heated enough (when making a milk based drink).	<p>Pre-heat cups.</p> <p>Check selected milk temperature setting.</p>
No crema	<ul style="list-style-type: none">• Coffee beans are stale.	<p>Use freshly roasted coffee beans with a 'Roaster On' date and consume between 5-20 days after that date.</p>



Guarantee

2 YEAR LIMITED GUARANTEE

Sage Appliances guarantees this product for domestic use in specified territories for 2 years from the date of purchase against defects caused by faulty workmanship and materials. During this guarantee period Sage Appliances will repair, replace, or refund any defective product (at the sole discretion of Sage Appliances).

All legal warranty rights under applicable national legislation will be respected and will not be impaired by our guarantee. For full terms and conditions on the guarantee, as well as instructions on how to make a claim, please visit www.sageappliances.com.



Notes



Notes

GBR

BRG Appliances Limited
Unit 3.2, Power Road Studios,
114 Power Road, London, W4 5PY
Freephone (UK Landline): 0808 178 1650
Mobile Calls (National Rate): 0333 0142 970

NLD

Netherlands
0800 020 1741

CHE

Switzerland
0800 009 933

DEU

AUT

Sage Appliances GmbH
Campus Fichtenhain 48, 47807 Krefeld,
Deutschland
Deutschland: 0800 505 3104
Österreich: 0800 80 2551

ITA

Italy
800 909 773

LUX

Luxembourg
800 880 72

ESP

Spain
900 838 534

DNK

Denmark
80 820 827

PTR

Portugal
0800 180 243

SWE

Sweden
0200 123 797

FRA

Sage Appliances France SAS
Siège social: 66 avenue des Champs
Elysées – 75008 Paris
879 449 866 RCS Paris
France: 0800 903 235

POL

Poland
08000 121 8713

FIN

Finland
0800 412 143

IRE

Ireland
1800 932 369

BEL

Belgium
0800 54 155

NOR

Norway
80 024 976

Sage®

www.sageappliances.com

Registered in England & Wales No. 8223512
Registered in Germany No. HRB 81309 (AG Düsseldorf)
Registered in France No. 879 449 866 RCS

EN Due to continued product improvement, the products illustrated or photographed in this document may vary slightly from the actual product.

DE Aufgrund unserer kontinuierlichen Produktverbesserungen kann die hier gezeigte Abbildung geringfügig vom tatsächlichen Produkt abweichen.

FR En raison de leur amélioration continue, les produits représentés ou photographiés dans le présent document peuvent différer légèrement du produit réel.

NL Vanwege voortdurende productverbeteringen, kunnen de afgebeelde producten in dit document licht afwijken van het eigenlijke product.

IT A causa del continuo miglioramento dei prodotti, il prodotto descritto o illustrato in questo documento può variare leggermente rispetto al prodotto reale.

ES Perfectionamos nuestros productos continuamente, por lo que el artículo podría diferir ligeramente de la ilustración o la fotografía en este documento.

PT Devido à melhoria contínua dos produtos, os produtos ilustrados ou fotografados neste documento podem variar ligeiramente do produto real.

PL Ze względu na stałe przeprowadzane ulepszenia, produkty przedstawione na ilustracjach lub zdjęciach w tym dokumencie mogą różnić się od używanego produktu.

DA På grund af løbende produktudvikling kan de illustrerede eller fotograferede produkter i dette dokument variere en smule fra det faktiske produkt.

SV På grund av kontinuerlig produktförbättring kan produkterna som visas i illustrationerna och fotografierna i detta dokument skilja sig något från den faktiska produkten.

FI Jatkuvan tuotekehittelyn seurauksena kuvituksen tuotteet eivät välttämättä ole täysin samanlaisia kuin varsinainen tuote.

NO På grunn av kontinuerlig produktutvikling kan produktene som er vist eller avfotografert i dette dokumentet, variere noe fra det faktiske produktet.

Copyright BRG Appliances 2022

BES881 / SES881 UK UG1 B22